

本企业通过ISO9001：2008质量管理体系标准

Wulian[®]

澳标墙面插座

使用说明书

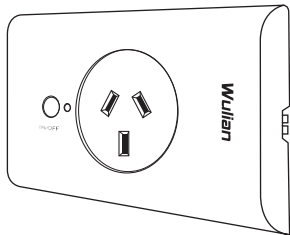

©2015 南京物联传感技术有限公司

出版号：2015-0618.V01

欢迎您使用Wulian澳标墙面插座产品说明书

- **Wulian**[®]是南京物联传感技术有限公司的注册商标。本说明书中提到所有其他产品名称或商标是其各自品牌所有者的商标或注册商标。
- 使用前请您认真阅读产品使用说明书，确保正确地、安全地使用。
- Wulian澳标墙面插座产品（以下简称“本产品”）为南京物联传感技术有限公司（以下简称“我司”）出品的智能家居插座类产品。本产品需要与智能家居相应APP客户端同步使用，并须使用本产品自带的配件，如您未正确地安装及使用本产品，而造成的损失，我司将不承担任何责任。
- 我司随时可能对本说明书中的产品信息进行更新，恕不另行通知。请您及时关注我司资讯，自行下载最新版APP客户端。
- 未经我司的明确书面许可，任何个人及企业不得复制本说明书的全部或部分内容，不得使用我司注册商标。对非法使用我司商标的行为，我司将依法追究行为人及企业法律责任。
- 欢迎您登录我司官网www.wulian.cc，了解更多智能家居产品信息。

产品展示

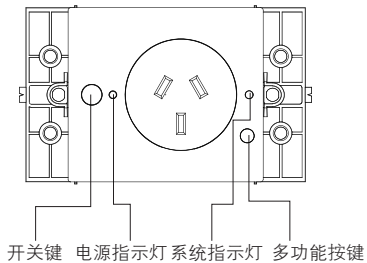

主体

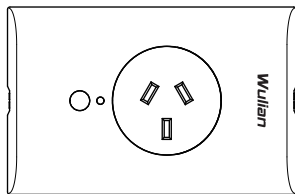

装饰盖

基本功能

- 全球领先过载断电保护，让您的生活更安心。
- 可通过APP客户端，远程遥控电器通、断电，让普通家电智能化。
- 实时反馈开关状态，支持局域网和远程控制插座电源的通断。
- 可自定义情景模式实现场景联动。

软件下载

下载方式一：

请扫描本产品包装盒上的二维码，下载最新版本软件客户端。

下载方式二：

官网下载地址：<http://www.wulian.cc/service.shtml>

温馨提示：初次使用时，请先安装APP客户端，并仔细阅读产品说明书；请时常关注我司资讯，以便及时更新。

安装指导

①墙面暗盒内电源线接入本产品接线端子。

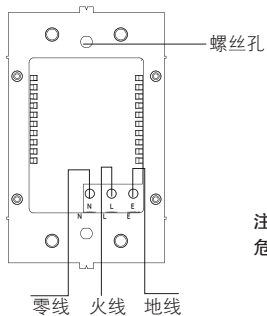

注：安装前请先确认电源已关闭！电工作业危险，非专业人士不得擅自操作！

②取下装饰盖，用两颗螺丝，将本产品固定在墙面暗盒内（安装方法与普通墙面开关安装方法相似）。

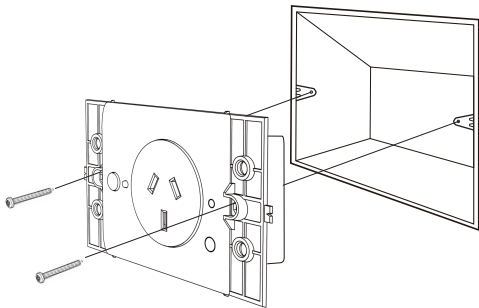

③装上装饰盖，安装完成（装上装饰盖前，请先进行联网设置）。

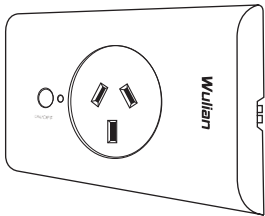

联网设置

①设置---加入ZigBee网络

快击【多功能按键】4次，单次快击时间不超过1秒，申请加入ZigBee网络；搜索网络中，【系统指示灯】呈绿色快速闪烁4次；成功入网后，【系统指示灯】呈绿色长亮2秒后熄灭。

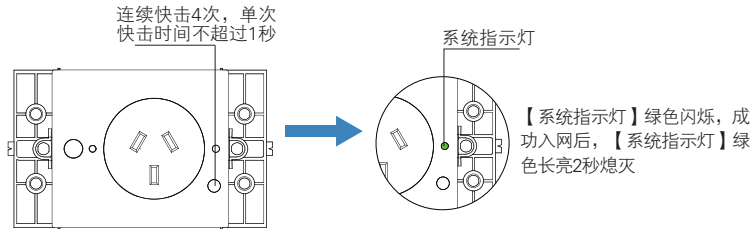

②设置---绑定

按住【多功能按键】，同时快击【开关键】1次，再松开【多功能按键】，【系统指示灯】闪烁1次并发出绑定请求，20s内以同样方式操作需要绑定设备，绑定操作成功【系统指示灯】呈绿色闪烁3次绑定操作失败【系统指示灯】呈绿色快速闪烁6次。

注：解除绑定操作方式和绑定步骤一致。

③设置---退出ZigBee网络

长按【多功能按键】10秒，【系统指示灯】呈绿色闪烁4次熄灭，本产品恢复为出厂设置，同时退出ZigBee网络。

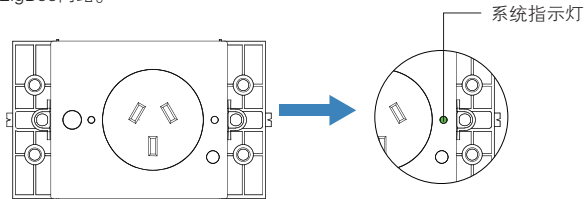

注：

- 设置前，请确认无线网关（需另外购买）正常工作，本产品处于网关有效通信距离内；如需远程控制，请将网关接入广域网。
- 当本产品需要加入到其他网关时，请先退出当前网关，再进行联网设置。

安装使用注意事项

- 安装前请先切断电源！带电作业危险，非专业人士不得擅自操作！
- 本产品务必安装在塑料暗盒中！如果安装在金属暗盒中，则可能削弱无线通信信号，从而降低通讯效率。
- 本产品应安装在干燥清洁的地方，以免内部元器件受潮或其他杂物进入而影响使用效果。
- 若本产品发生故障，非专业人员不得拆开产品，应送到当地维修点进行维修，或直接与我司客服联系。

规格参数

结构参数

外形尺寸 (长×宽×高, mm)	115.6×75×44.2
材质、颜色	PC+ABS、白色
阻燃等级	UL94 V-0
净重 (g)	145

通用参数

电源参数	250VAC, 50Hz
额定最大电流	10A
待机功耗	≤0.3W
最大阻性负载	2500W (白炽灯、卤素灯等阻性负载)
最大感性、容性负载	1500W (节能灯, 日光灯, LED等感性、容性负载)
工作环境温湿度	-10℃ ~ +45℃ ≤95%RH (不凝结)

射频参数

通讯协议	IEEE 802.15.4 ZigBee/SmartRoom
天线类型	PCB天线

说明

- 本产品支持手动控制和电动操作控制
- 自动操作：Type 1.B
- 污染程度：2
- 额定脉冲电压：2500V
- 第一类设备；
- 断开类型：micro-disconnection

订购信息

产品名称	Wulian澳标墙面插座
产品型号	WL-ZSKWNPW-W3120-01
材质、颜色	PC+ABS，白色
货号	WLPN140617002

南京市雨花台区凤集大道15号创业创新城-北柚11栋

邮编：210039

服务热线：400-928-9288

官网：www.wulian.cc

The company passed the ISO9001: 2008 quality management system standard

Wulian®

Smart Wall Socket-Outlet (Australian Type)

User Manual

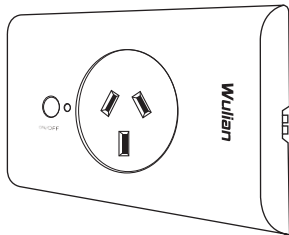

©2015 Nanjing IOT Sensor Technology Co., Ltd.

Publication Number: 2015-0618.V01

Welcome to Use Smart Wall Socket-Outlet (Australian Type) User Manual

- **Wulian**[®] is the registered trademark of Nanjing IOT Sensor Technology Co., Ltd. All the other trademarks and registered trademarks mentioned in this manual are trademarks or registered trademarks of their respective owners.
- Please read this manual carefully for the proper use of this product.
- Smart Wall Socket-Outlet (Australian Type) (hereinafter referred to as “this product”) are smart home socket products produced by Nanjing IOT Sensor Technology Co., Ltd. (hereinafter referred to as “Wulian”). This product shall be used with smart home APP as well as the supplied accessories. Wulian is not responsible for any loss due to improper installation and usage of this product.
- Please check the Wulian website periodically for manual and APP update availability and the relevance.
- Without the written permission of Wulian, any individuals and enterprises shall not copy all or part of the contents of this manual, or use our registered trademark. Any illegal use of our trademarks shall be investigated according to law.
- For more information about smart home products, please visit: www.wulian.cc/english

Product Illustration

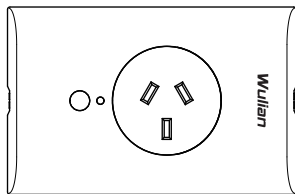
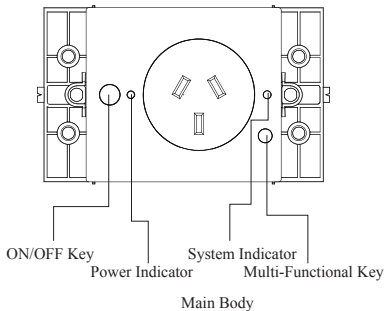

Features

- Use the leading overload protection in the world to make your life easier.
- Remotely control connecting to power, or shutting down power for home appliances by smart home APP. Auto-timing control function of energy saving makes common appliances smart.
- Real-time feedback on ON/OFF status supports connecting to power, or shutting down power for socket via LAN & remote control.
- Customize contextual mode, support joining scene mode, have functions such as reservation & timing, electric energy statistics, and view history.

Software Download

Option A:

Download the latest smart APP by scanning QR code on the package box of this product.

Option B:

iOS user can download the APP by searching "Wulian Smart home" in "APP Store".

Android user can download the APP by searching "Wulian Smart home" in "Google Play".

Warm prompt: For the first use, please download smart home APP and read user manual carefully. Please pay attention to Wulian information to download the latest APP in time.

Installation Instruction

- ① Connect power line to connecting terminal of this product in the wall inner box.

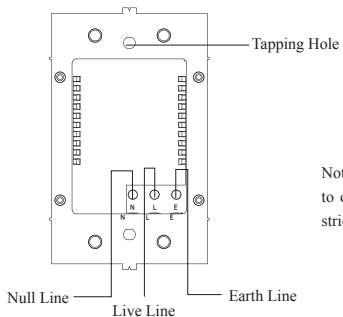

Notes: Cut down power before installation! It's dangerous to operate with power on, non-professional operation is strictly prohibited!

② Remove the housing, and fix this product via 2*screw in the wall inner box (Installation method is same as that of common wall switch).

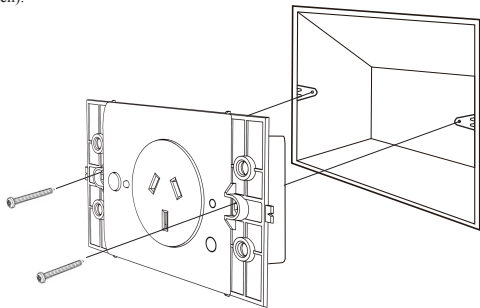

③ Close the housing to finish installation (Please join the network before closing the housing).

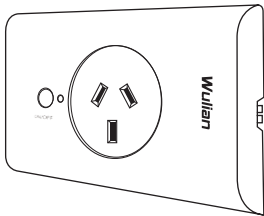

Network Setting

1.Add ZigBee Network

Quickly click [Multi-Function Key] 4 times to apply for joining ZigBee network. While searching network, [System Indicator] flashes green 4 times quickly. After joining ZigBee network successfully, [System Indicator] stays green 2s, and then goes out.

Quickly click [Multi-Function Key] 4 times, and each click is less than 1s.

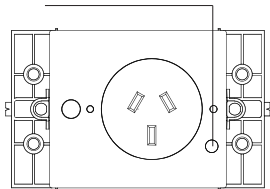

System Indicator

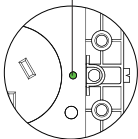

[System Indicator] flashes green. After joining ZigBee network successfully, [System Indicator] stays green 2s, and then goes out.

2.Binding

Long press [Multi-Function Key] while click [ON/OFF Key] once quickly. Then loosen [Multi-Functional Key], [System Indicator] flashes once to send binding request. Bind device that requires binding within 20S with same steps. If binding succeeds, [System Indicator] flashes green 3 times. If binding fails, [System Indicator] flashes green 6 times quickly.

Notes: Operating method of removing binding is same as that of binding.

3.Exit ZigBee Network

Long press [Multi-Function Key] 10S. [System Indicator] flashes green 4 times, and then goes out to restore to factory setting. Meanwhile, this product exits ZigBee network.

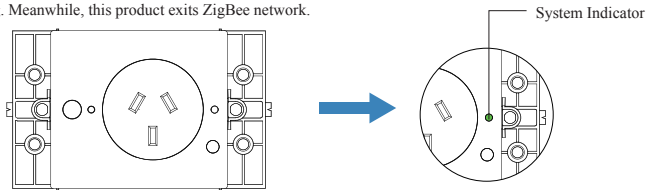

Notes:

- Before setting, please confirm gateway (additional purchase) works normally. Make sure this product is within effective communication range of gateway. If remote control is required, please connect gateway to wide area network.
- When this product needs joining other gateways, please exit the current gateway before networking.

Cautions

- Cut down the power before installation! It's dangerous to operate with power on. Non-professional operation is strictly prohibited.
- This product must be installed in the plastic box! Installation in the metal cassette may weaken wireless communication signals so that it may lower the communication efficiency.
- This product should be installed in dry and clean place to prevent inner component from dampness or other debris.
- If this product breaks down, non-professional staff shall not handle it. Send it to local service center for repair, or contact our customer service staff.

Specification Parameter

Structure Parameter

Overall Dimension (L×W×H, mm)	115.6×75×44.2
Material & Color	PC+ABS、 White
Flame Retardant Rating	UL94 V-0
Net Weight (g)	145

General Parameter

Power Parameter	250VAC, 50Hz
Maximum Rated Current	10A
Stand-by Power Consumption	≤0.3W
Maximum Load Impedance	2500W(Incandescent Lamp/Halogen Lamp)
Maximum Inductive /Capacitive Load	1500W(Energy Saving Lamp/Fluorescent Lamp/LED)
Working Temperature	-10℃ ~+45℃ ≤95%RH (Noncondensing)

Radio Frequency Parameter

Communication Protocol	IEEE 802.15.4 ZigBee/SmartRoom
Antenna Type	PCB Antenna

Notes

- This product supports manual control and automatic control
- Automatic Control: Type 1.B
- Pollution Level: 2
- Rated Impulse Voltage: 2500V
- First Kind Device
- Disconnection Type: micro-disconnection

Purchase Information

Product Name	Smart Wall Socket-Outlet (Australian Type)
Model	WL-ZSKWNPW-W3120-01
Material & Color	PC+ABS, White
Item No.	WLPN140617002

Building 11, No.15, Fengji Road, Yuhuatai District, Nanjing (P. C.: 210039)

Email: overseas@wuliangroup.com

Service Hotline: 400-889-2891

www.wulian.cc/english